

P/N: FAUI392163

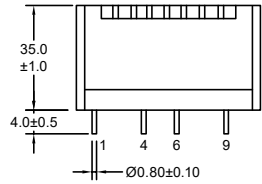

Outline Dimensions (Unit:mm)



Side View

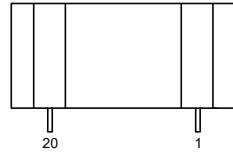

Front View

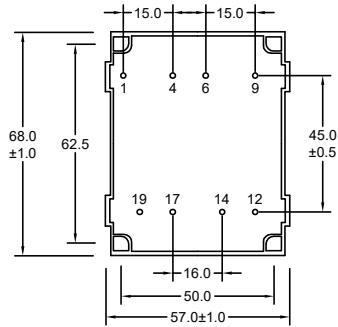

Bottom View

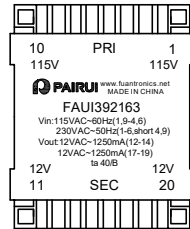

Top View

Note:

- 1.Remove Pins 2,3,5,7,8,10,11,13,15,16,18,20.

Wave Soldering

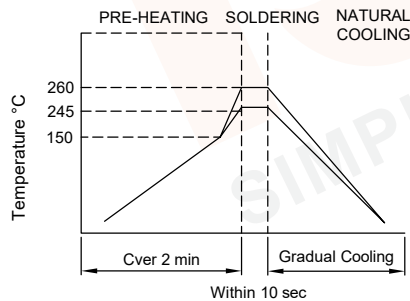

- Note:
- 1.Never Contact the ceramic with the iron tip;
  - 2.1.0mm tip diameter(max).

Electronical Schematic

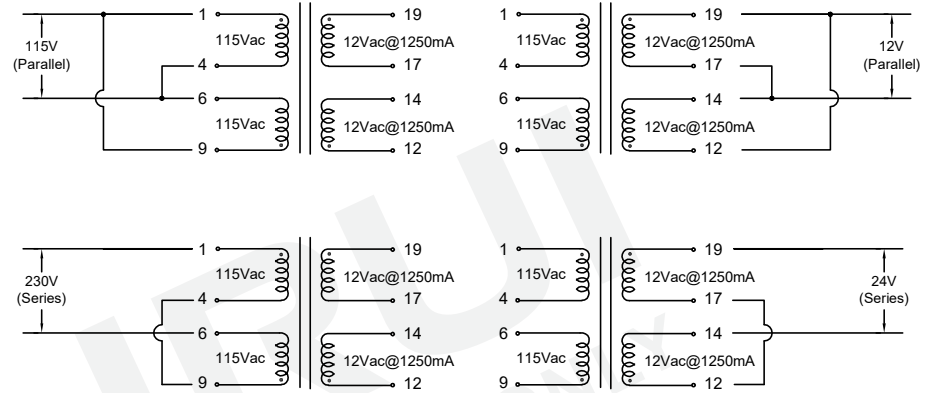

Electrical Characteristics

- Input 115Vac 60Hz to (1,9-4,6) or 230Vac 50Hz to (1-6,short 4,9) :
- Excitation current(Ix):25mA Max.
- Output: Vo(12-14)=13.5Vac Typ(No-load).
- Vo(17-19)=13.5Vac Typ(No-load).
- VL(12-14)=12.0Vac±5%(@1250mA).
- VL(17-19)=12.0Vac±5%(@1250mA).
- Hi-Pot: Pri-Sec:4000VAC/5mA/60Second.

General Properties

- Operating Temperature:-40°C to +40°C.
- Storage Temperature:-25°C to +85°C.
- Insulation Class: B.
- Weight: 0.53kg.

				Tianchang Fuan Electronic Co Ltd www.fuantronics.net TEL: +86-550-7814888 FAX: +86-550-7831133	 Tolerances unless otherwise specified: (.X)±0.50 (XX)±0.25 Unit of measurement: mm	Make: Qiumei.Liu Checked: Beson. zhan Approved: Anson. zhan	<b>DRAWING TITLE</b> 30.0W Encapsulated Transformer For UI39*21.2*115VAC Input 50/60Hz Material Number: A223921XS020	Customer Name: Document/Rev: Specification Sheet: 1 of 2 Date of Recognition: Jan./02/2020
REV	DESCRIPTION	APPD	DATE					

P/N: FAUI392163

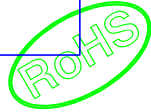

List of UL Certificate:

No.	Part Name	Mat'l Description	Supplier	UL Number
1	Bobbin	UI39*21/PBT(Black)	Chang Chun Plastics Co Ltd	E59481
2	Case	CASE-UI39*21/PBT(Black)	Zhejiang Juner New Materials Co Ltd	E204321
3	Copper wire	2UEW-F/155C	Elektrisola Hangzhou Co Ltd	E258243
4	Core	Lamination	Ta Yea Steel Industry Co Ltd	N/A
5	Epoxy	PU552(Black)	Wevo-Chemle Gmbh	E108835
6				

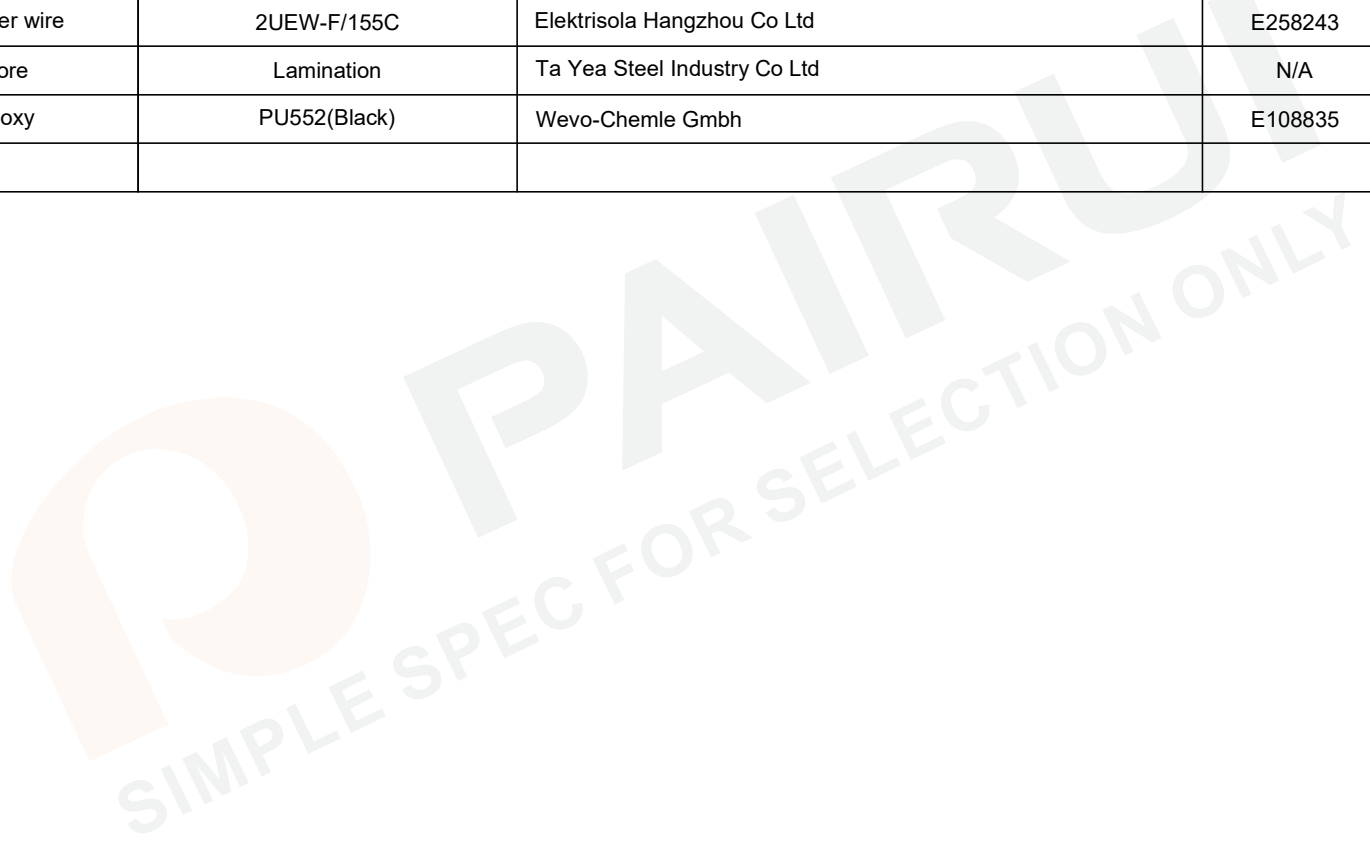

				Tianchang Fuan Electronic Co Ltd www.fuantronics.net TEL: +86-550-7814888 FAX: +86-550-7831133	Tolerances unless otherwise specified: (.X)±0.50 (XX)±0.25 Unit of measurement: mm	Make: Qiumei.Liu	<b>DRAWING TITLE</b> 30.0W Encapsulated Transformer For UI39*21,2*115VAC Input 50/60Hz	Customer Name:
						Checked: Beson. zhan Approved: Anson. zhan		Document/Rev: Specification Sheet: 2 of 2
REV	DESCRIPTION	APPD	DATE				Material Number: A223921XS020	